

# Self Supporting Probes 自重型

## Model WE series WE 系列

**New**

- Model WE series are temperature sensors designed for stationary surfaces. These self-supporting probes can be used to measure temperature simply by placing the probe on the measurement target.
- WE 系列产品是静止表面温度传感器，因传感器内部配置砝码，只需置放在测试对象表面即可测试温度。
- Specific components may be combined to customize products for the needs of a customer's specific application.
- 通过组合各个规格的组件，可以按照客户的用途进行个性选配。

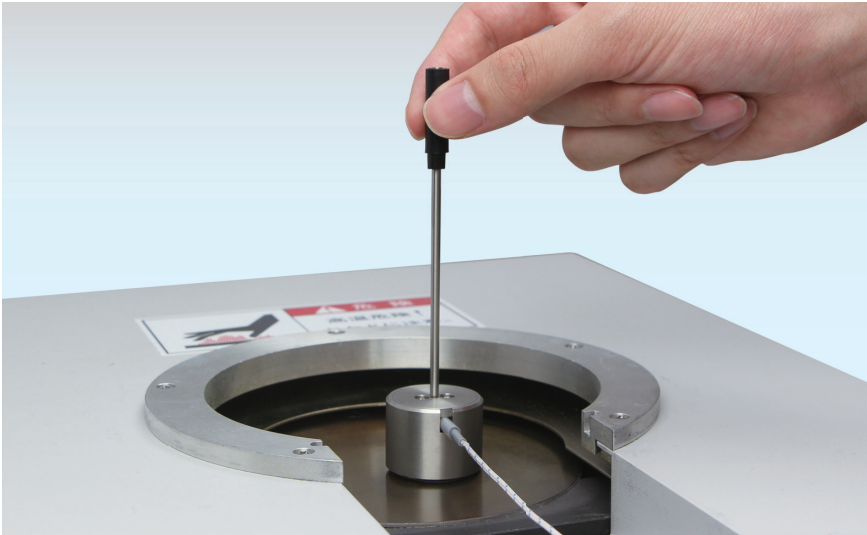

Type K model : **WE-12K-GW1-ANP**

Type E model : **WE-12E-GW1-ANP**

Temp.range 温度范围	Tolerance 精准度	Response time 响应速度
-50~500°C	±2.5°C*	1s

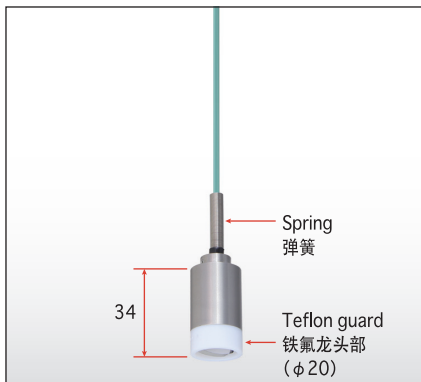

Type K model : **WE-11K-TS1-ANP**

Type E model : **WE-11E-TS1-ANP**

Temp.range 温度范围	Tolerance 精准度	Response time 响应速度
-50~250°C	±2.5°C*	1s



Type K model : **WE-13K-TS1-ANP**

Type E model : **WE-13E-TS1-ANP**

Temp.range 温度范围	Tolerance 精准度	Response time 响应速度
-50~250°C	±2.5°C*	1s



Type K model : **WE-33K-TA1-ANP**

Type E model : **WE-33E-TA1-ANP**

Temp.range 温度范围	Tolerance 精准度	Response time 响应速度
-50~200°C	±2.5°C*	2s



Type K model : **WE-22K-GW1-ANP**

Type E model : **WE-22E-GW1-ANP**

Temp.range 温度范围	Tolerance 精准度	Response time 响应速度
-50~500°C	±2.5°C*	1s



Type K model : **WE-24K-GW1-ANP**

Type E model : **WE-24E-GW1-ANP**

Temp.range 温度范围	Tolerance 精准度	Response time 响应速度
-50~500°C	±2.5°C*	1s



Type K model : **WE-44K-GW1-ANP**

Type E model : **WE-44E-GW1-ANP**

Temp.range 温度范围	Tolerance 精准度	Response time 响应速度
-50~500°C	±2.5°C*	2.5s

\* at 100°C surface / 100°C 表面

# CUSTOMIZE

ANRITSU METER THERMOCOUPLE PROBES FREE COMPONENT SERIES



## WE series [ Customization 选型 ]

Specific components may be combined to customize products for the needs of a customer's specific application.  
可根据多种多样的用途进行选型。可根据客户的用途自由搭配。

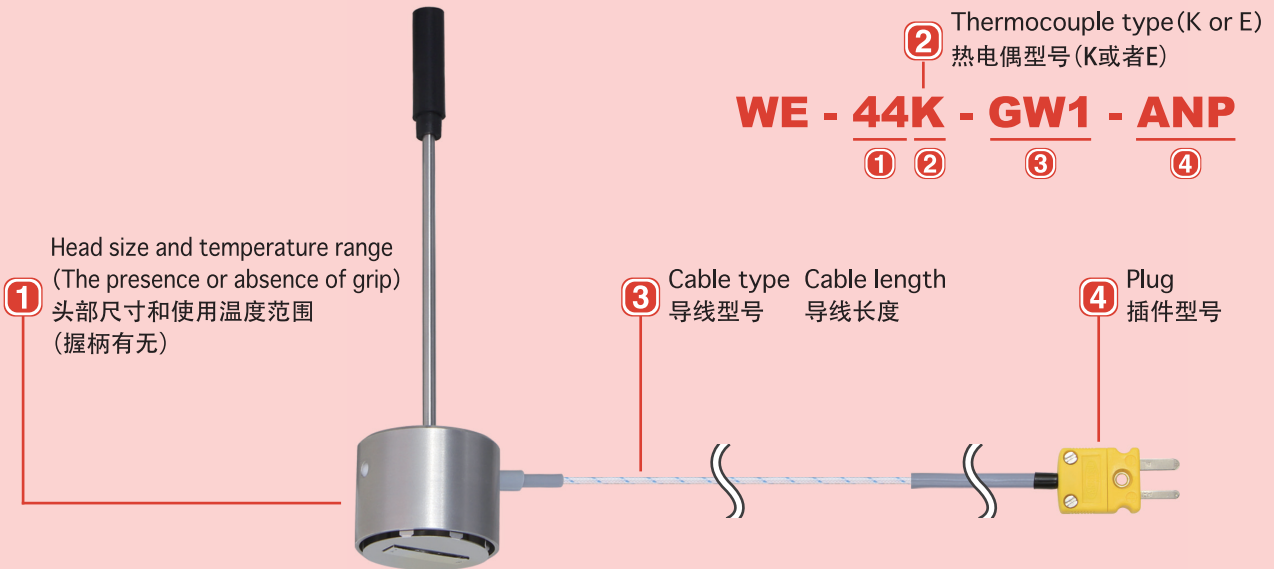

### 1 Head size and temperature range (No grip) 头部尺寸和使用温度范围 (无握柄)

Select the type according to the environment, such as stability, the size of the measurement surface.  
请根据所测量物体的大小, 温度稳定性等环境进行选择。

无握柄	低温用	<p><b>WE-11</b> Temp. range 温度范围: -50 ~ 250°C</p> <p>Weight : approx. 60g 重量: 约60g</p>	<p><b>WE-21</b> Temp. range 温度范围: -50 ~ 250°C</p> <p>Weight : approx. 145g 重量: 约145g</p>	<p><b>WE-31</b> Temp. range 温度范围: -50 ~ 200°C</p> <p>Weight : approx. 25g 重量: 约25g</p>
	高温用	<p><b>WE-12</b> Temp. range 温度范围: -50 ~ 500°C</p> <p>Weight : approx. 70g 重量: 约70g</p>	<p><b>WE-22</b> Temp. range 温度范围: -50 ~ 500°C</p> <p>Weight : approx. 150g 重量: 约150g</p>	<p><b>WE-42</b> Temp. range 温度范围: -50 ~ 500°C</p> <p>Weight : approx. 70g 重量: 约70g</p>

# 1 Head size and temperature range (Standard grip) 头部尺寸和使用温度范围 (有握柄)

Select the type according to the environment, such as stability, the size of the measurement surface.  
 请根据所测量物体的大小, 温度稳定性等环境进行选择。

有握柄 Standard grip	低温用 Low temperature	<p><b>WE-13</b> Temp. range 温度范围: -50 ~ 250°C</p> <p>Weight : approx.70g 重量: 約70g</p>	<p><b>WE-23</b> Temp. range 温度范围: -50 ~ 250°C</p> <p>Weight : approx.165g 重量: 約165g</p>	<p><b>WE-33</b> Temp. range 温度范围: -50 ~ 200°C</p> <p>Weight : approx.25g 重量: 約25g</p>
	高温用 High temperature	<p><b>WE-14</b> Temp. range 温度范围: -50 ~ 500°C</p> <p>Weight : approx.80g 重量: 約80g</p>	<p><b>WE-24</b> Temp. range 温度范围: -50 ~ 500°C</p> <p>Weight : approx.170g 重量: 約170g</p>	<p><b>WE-44</b> Temp. range 温度范围: -50 ~ 500°C</p> <p>Weight : approx.70g 重量: 約70g</p>

※ The grip is detachable. 握柄可自行拆卸。

# 2 Thermocouple type 热电偶型号

Select the same thermocouple type as thermometer.  
 选择与温度计主机同型号的热电偶

Select a Type-K or Type-E thermocouple.  
 选择热电偶种类, K 型或 E 型。

When thermocouple type of thermometer is Type-K 温度计主机的热电偶型号 [ K 型 ]	When thermocouple type of thermometer is Type-E 温度计主机的热电偶型号 [ E 型 ]
<b>K</b> Chromel-Alumel	<b>E</b> Chromel-Constantan

# 3 Cable type Cable length 导线型号 导线长度

The cable length can be specified in 0.5m increments.  
 可以指定导线长度, 单位为 0.5m。

Standard specifications 标准导线





- WE-11, 13, 21, 23 . . . . . TS cable 1m
- WE-12, 14, 22, 24, 42, 44 . . . . . GW cable 1m
- WE-31, 33 . . . . . TA cable 1m

	Thermocouple type 对应热电偶种类	Cable outer diameter 导线外径	Sheath material 材质	Heat resistant 耐温	Notes 备考
<b>TS</b>	K, E	φ 2.3mm	Silicone rubber 硅胶	240°C	For WE-11, 13, 21, 23
<b>GW</b>	K, E	1.2×1.7mm	Glass fiber 玻璃纤维	300°C	For WE-12, 14, 22, 24, 42, 44
<b>TA*</b>	K, E	φ 0.9mm	Teflon 铁氟龙	200°C	For WE-31, 33

\* The resistance value of the TA cable is 160Ω/m. Please be careful about source resistance of the thermometer. TA导线的电阻值为160Ω/m, 请确认温度计主机的电阻值。

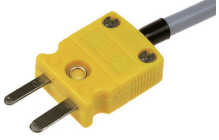
#### 4 Plug 插件型号

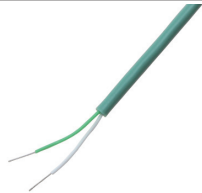
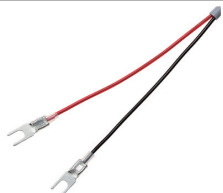
Select the type that best fits the shape of the plug of the thermometer. 请选择与温度计主机的插件形状符合的插头。

ANP	ASP	W	WT3 WT4 WT5	WC3 WC4 WC5
Miniature plug	Anritsu standard plug	Without plug	Spade terminal for $\phi$ 3mm Spade terminal for $\phi$ 4mm Spade terminal for $\phi$ 5mm	Ring terminal for $\phi$ 3mm Ring terminal for $\phi$ 4mm Ring terminal for $\phi$ 5mm
				

#### Specifications of WE WE 系列的规格

Model number 型号	WE-11 ■ WE-13 ■ WE-21 ■ WE-23 ■	WE-12 ■ WE-14 ■ WE-22 ■ WE-24 ■	WE-31 ■ WE-33 ■	WE-42 ■ WE-44 ■
Thermocouple type 热电偶型号	Type K or E K 型或 E 型			
Temp. range 温度范围	-50~250°C	-50~500°C	-50~200°C	-50~500°C
Tolerance 精度	0°C	±2.5°C	±2.5°C	±2.5°C
	100°C	±2.5°C	±2.5°C	±2.5°C
	200°C	±2.5°C	±2.5°C	±2.5°C
	300°C	—	±2.5°C	±2.5°C
	400°C	—	±3.0°C	±3.0°C
	500°C	—	±3.8°C	±3.8°C
Tolerance calculation method t: Temperature 精度度的计算方法 t: 温度	In the operating temperature range 使用温度范围 0°C ≤ t < 333°C : ±2.5°C 333°C ≤ t ≤ 500°C : ±(0.0075 × t)°C			
Response time 响应速度	1s	1s	2s	2.5s
Durability 耐久性	More than 50,000 contacts			
Guard material 头部材质	Teflon 铁氟龙	Stainless 不锈钢 (SUS303)	Inconel 镍铬铁合金	Stainless 不锈钢 (SUS304)
Body material 本体材质	Stainless 不锈钢 (SUS303)			
Repair 修理	Repairable 可修理			

- ※1 The (■) symbol is replaced by the corresponding thermocouple type (K or E). In addition, The form of probe later the thermocouple type are omitted. 型号的 ■ 里输入热电偶种类 (K 型或 E 型)。并, 省略热电偶种类以下的型号。
- ※2 Please note that the operating temperature range is the temperature range in which the temperature measuring part of the probe and the guard etc can contact, and it is not applied otherwise. 使用极限温度是根据传感器前端的耐热温度来决定。请注意, 夹扣, 导线和插头等部分的耐热温度与使用极限温度有一定的差异。
- ※3 Tolerance is available at 0°C or above within the operating temperature on a stationary flat and smooth metal surface 为测量 0°C 以上的静止光滑金属表面温度的精度度。
- ※4 The response time is the time required to detect 99% of the true value on a stationary flat and smooth metal surface. 响应速度是指, 测量 0°C 以上的静止光滑金属表面温度时达到 99% 的温度显示的速度。
- ※5 Number of contacts enabling measurement within the tolerance range on a flat and smooth metal surface at a temperature of 300°C (or at the operating temperature limit if the operating temperature limit is below 300°C) 在精度度要求范围内, 用机器制动测量 (300°C 或测量范围上限温度的) 静止光滑金属表面温度时, 所能测量的次数。

#### How to order 如何选择

#### WE - 44K - GW1 - ANP

	①	②	③	④
① Head size and temperature range (The presence or absence of grip) 头部尺寸和使用温度范围 (握柄有无)	11	$\phi$ 20 × 34mm	No grip	-50 ~ 250°C
	12	$\phi$ 20 × 34mm	No grip	-50 ~ 500°C
	13	$\phi$ 20 × 39mm	Standard grip	-50 ~ 250°C
	14	$\phi$ 20 × 39mm	Standard grip	-50 ~ 500°C
	21	$\phi$ 30 × 34mm	No grip	-50 ~ 250°C
	22	$\phi$ 30 × 34mm	No grip	-50 ~ 500°C
	23	$\phi$ 30 × 39mm	Standard grip	-50 ~ 250°C
	24	$\phi$ 30 × 39mm	Standard grip	-50 ~ 500°C
	31	$\phi$ 20 × 15mm	No grip	-50 ~ 200°C
	33	$\phi$ 20 × 15mm	Standard grip	-50 ~ 200°C
② Thermocouple type 热电偶型号	K	Chromel-Alumel		
	E	Chromel-Constantan		
③ Cable type 导线型号	TS	$\phi$ 2.3mm Silicone rubber insulated cable (WE-11, 13, 21, 23) 硅胶		
	GW	1.2 × 1.7mm Glass fiber insulated cable (WE-12, 14, 22, 24, 42, 44) 玻璃纤维		
	TA <sup>※6</sup>	$\phi$ 0.9mm Teflon insulated cable 铁氟龙 (WE-31, 33)		
④ Plug 插件型号	1	1m		
	2	2m		
	⋮	⋮		
④ Plug 插件型号	ANP	Miniature plug		
	ASP	Anritsu standard plug		
	W	Without plug		
	WT3	Spade terminal for $\phi$ 3mm		
	WT4	Spade terminal for $\phi$ 4mm		
	WT5	Spade terminal for $\phi$ 5mm		
	WC3	Ring terminal for $\phi$ 3mm		
WC4	Ring terminal for $\phi$ 4mm			
WC5	Ring terminal for $\phi$ 5mm			

- ※6 The resistance value of the TA cable is 160Ω/m. Please be careful about source resistance of the thermometer. TA 导线的电阻值为 160Ω/m, 请确认温度计主机的电阻值。

USA, Canada, Mexico

**ANRITSU** 安立計器株式会社  
ANRITSU METER CO., LTD.  
2-4-5, Shimomeguro,  
Meguro-ku, Tokyo 153-0064, JAPAN  
Phone : 81-3-3491-9181  
Telefax : 81-3-3493-6729  
<https://www.anritsu-meter.com>  
sales@anritsu-meter.co.jp

Shinyei Corporation of America  
1120 Avenue of the Americas,  
4th floor, New York, NY 10036  
TEL : 917-484-7884  
Email : sensor@sca-shinyei.com